



Dearborn Protocol Adapter (DPA) and PLC TestCon Pinouts and Industry Connectors Reference Guide Including the J1939 Type-2 Connector

Document Revision 2.0
Document Date: 01/09/12
Copyright: Copyright © 2012 Dearborn Group, Inc.

Permission is granted to copy any or all portions of this manual, provided that such copies are for use with a Dearborn Group, Inc. product and that the name "Dearborn Group, Inc." remains on all copies.

Disclaimer: The information in this documentation is for reference purposes only. Attention has been made to ensure this information is correct, however connectors and pinouts change, therefore Dearborn Group, Inc. will not be held responsible for any damages incurred by using the information printed in this document.

1. DPA 4 and DPA 5 Series (Color and Black/White Table)

DPA variants up to and including the DPA 4 Plus were pinned out according to the printing on the DPA endplate (i.e. "/T", "/MH", etc). These tables provide a list of most of the DPA adapters that may still be in service. If you cannot find your adapter in this list, please do not hesitate to call DG technical support.

Signal	DPA5 Dual CAN/BT	DPA 5 Quad CAN	DPA 4/4 Plus	DPA 4 Dual CAN
Ground	6	6	6	6
Power (9-32vdc)	8	8	8	8
J1708-	14	14	14	14
J1708+	15	15	15	15
CAN1 Shield	7	7	7	7
CAN1 Lo	12	12	12	12
CAN1 Hi	13	13	13	13
CAN1 Term 1	3	3	3	3
CAN1 Term 2	4	4	4	4
CAN TX				
CAN RX				
SW CAN	10	10	10	10
ALDL/GM UART	16	16	1	1
ALDL RX				
9141 K Line	1	1		
9141 L Line	11	11		
J1850 Hi	5	5	5	5
J1850 Lo				
ATEC Data				
ATEC Diag				
Discrete In				
Discrete Out				11
CAN2 Term 1	20	20		20
CAN2 Term 2	21	21		21
CAN2 Shield	23	23		23
CAN2 Lo	22	22		22
CAN2 Hi	24	24		24
LIN				
HALDEX				
CAN3 Lo		2		
CAN3 Hi		17		
CAN3 Shield		18		
CAN4 Lo		19		
CAN4 Hi		9		
CAN4 Shield		25		

Signal	DPA5 Dual CAN/BT	DPA 5 Quad CAN	DPA 4/4 Plus	DPA 4 Dual CAN
Ground	6	6	6	6
Power (9-32vdc)	8	8	8	8
J1708-	14	14	14	14
J1708+	15	15	15	15
CAN1 Shield	7	7	7	7
CAN1 Lo	12	12	12	12
CAN1 Hi	13	13	13	13
CAN1 Term 1	3	3	3	3
CAN1 Term 2	4	4	4	4
CAN TX				
CAN RX				
SW CAN	10	10	10	10
ALDL/GM UART	16	16	1	1
ALDL RX				
9141 K Line	1	1		
9141 L Line	11	11		
J1850 Hi	5	5	5	5
J1850 Lo				
ATEC Data				
ATEC Diag				
Discrete In				
Discrete Out				11
CAN2 Term 1	20	20		20
CAN2 Term 2	21	21		21
CAN2 Shield	23	23		23
CAN2 Lo	22	22		22
CAN2 Hi	24	24		24
LIN	18			18
HALDEX				
CAN3 Lo		2		
CAN3 Hi		17		
CAN3 Shield		18		
CAN4 Lo		19		
CAN4 Hi		9		
CAN4 Shield		25		

2. DPA II and III Series, and other Legacy DPA Products (Color Table)

DPA variants up to and including the DPA 4 Plus were pinned out according to the printing on the DPA endplate (i.e. "/T", "/MH", etc). These tables provide a list of most of the DPA adapters that may still be in service. If you cannot find your adapter in this list, please do not hesitate to call our technical support department and we will provide you with the correct pinouts and the list of protocols your variant supports.

Signal	DPA II	DPA II /T	DPA II DDE	INLINE II	DPA III	DPA III+ /M	DPA III+ /MH	DPA III+ /MHSW	DPA III+ /T & /I	DPA III+ /TSW	DPA III+ /C	DPA III+ /SCP	DPA ISA	DPA PC/104
Ground	9	6	6	25	9	9	9	9	6	6	9	6	6	11
Power (9-32vdc)	10	8	8	23	10	10	10	10	8	8	10	8		
J1708 Lo	11	14	14	4	11	11	11	11	14	14	11	14	14	12
J1708 Hi	12	15	15	3	12	12	12	12	15	15	12	15	15	14
CAN Shield	13	7	7	7	13	13	13	13	7	7	13	7	7	13
CAN Lo	14	12	12	8	14	14	14	14	12	12	14	12	12	8
CAN Hi	15	13	13	6	15	15	15	15	13	13	15	13	13	10
CAN Term 1	7	3	3	19	7	3	3	3	3	3	7	3	3	5
CAN Term 2	8	4	4	20	8	4	4	4	4	4	8	4	4	7
CAN TX					3									
CAN RX					4									
SW CAN								6		10		10		
ALDL					1	1	1	1	1	1	1	1	1	1
ALDL RX							2	2						
Master/Slave 1					2	2			2	2	2	2	2	3
Master/Slave 2					6	6	6		10		6		10	4
9141 K Line											1			
9141 L Line											3			
J1850 Hi					5	5	5	5	5	5	5	5	5	9
J1850 Lo												9		
External Power													8	15
External Ground													9	2
A TEC Data						7	7	7						
A TEC Diag						8	8	8						
Discrete In									9	9	4			
Discrete Out									11	11		11		

3. DPA II and III Series, and other Legacy DPA Products (Black/White Table)

DPA variants up to and including the DPA 4 Plus were pinned out according to the printing on the DPA endplate (i.e. "/T", "/MH", etc). These tables provide a list of most of the DPA adapters that may still be in service. If you cannot find your adapter in this list, please do not hesitate to call our technical support department and we will provide you with the correct pinouts and the list of protocols your variant supports.

Signal	DPA II	DPA II /T	DPA II DDE	INLINE II	DPA III	DPA III+ /M	DPA III+ /MH	DPA III+ /MHSW	DPA III+ /T & /I	DPA III+ /TSW	DPA III+ /C	DPA III+ /SCP	DPA ISA	DPA PC/104
Ground	9	6	6	25	9	9	9	9	6	6	9	6	6	11
Power (9-32vdc)	10	8	8	23	10	10	10	10	8	8	10	8		
J1708 Lo	11	14	14	4	11	11	11	11	14	14	11	14	14	12
J1708 Hi	12	15	15	3	12	12	12	12	15	15	12	15	15	14
CAN Shield	13	7	7	7	13	13	13	13	7	7	13	7	7	13
CAN Lo	14	12	12	8	14	14	14	14	12	12	14	12	12	8
CAN Hi	15	13	13	6	15	15	15	15	13	13	15	13	13	10
CAN Term 1	7	3	3	19	7	3	3	3	3	3	7	3	3	5
CAN Term 2	8	4	4	20	8	4	4	4	4	4	8	4	4	7
CAN TX					3									
CAN RX					4									
SW CAN								6		10		10		
ALDL					1	1	1	1	1	1	1	1	1	1
ALDL RX							2	2						
Master/Slave 1					2	2			2	2	2	2	2	3
Master/Slave 2					6	6	6		10		6		10	4
9141 K Line											1			
9141 L Line											3			
J1850 Hi					5	5	5	5	5	5	5	5	5	9
J1850 Lo												9		
External Power													8	15
External Ground													9	2
ATEC Data						7	7	7						
ATEC Diag						8	8	8						
Discrete In									9	9	4			
Discrete Out									11	11		11		

4. Deutsch Connectors (3/6/9-Pin)

NOTE: On the Deutsch 9-pin SAE Standard Heavy-Duty Truck Connector, pins H and J are labeled "OEM Specific". Some truck OEMs have used these pins differently (i.e. PACCAR and ISO9141), however the most common use of these pins is for a second CAN channel (i.e. Freightliner Cascadia). It has been requested of all diagnostic adapter vendors by the TMC RP1210 task force to use blue colored sheathing on their vehicle-side cables that are wired for a second CAN channel (as per the Freightliner Cascadia model). DG uses blue colored sheathing on our DPA 5 cables that support a second CAN channel.

4.1. 3-Pin Deutsch - J1939 Backbone Connector

Pin	Value
A	CAN/J1939 Hi
B	CAN/J1939 Lo
C	CAN/J1939 Shield

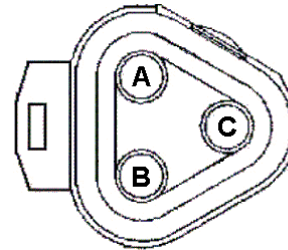

4.2. 6-Pin Deutsch – Commonly Called the J1708/J1587 Heavy-Duty Truck Connector

Pin	Value
A	J1708/J1587 Hi
B	J1708/J1587 Lo
C	+12V
D	OEM Specific
E	Ground
F	OEM Specific

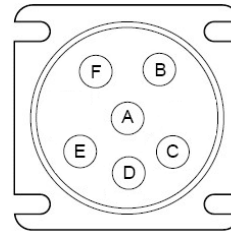

4.3. 9-Pin Deutsch – SAE Standard Heavy-Duty Truck Connector

Pin	Value
A	Ground
B	+12V
C	CAN/J1939 Hi
D	CAN/J1939 Lo
E	CAN/J1939 Shield
F	J1708/J1587 Hi
G	J1708/J1587 Lo
H	OEM Specific
J	OEM Specific

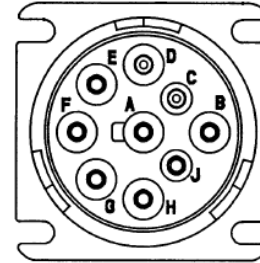

4.4. 9-Pin Deutsch – Freightliner Cascadia (H,J Used for Dual CAN)

Pin	Value
A	Ground
B	+12V
C	CAN/J1939 Hi
D	CAN/J1939 Lo
E	CAN/J1939 Shield
F	J1708/J1587 Hi
G	J1708/J1587 Lo
H	CAN 2 Hi
J	CAN 2 Lo

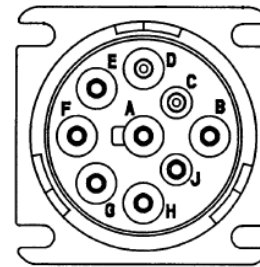

4.5. 9-Pin Deutsch – PACCAR (J Used for ISO9141 K-Line)

Pin	Value
A	Ground
B	+12V
C	CAN1/J1939 Hi
D	CAN1/J1939 Lo
E	CAN1/J1939 Shield
F	J1708/J1587 Hi
G	J1708/J1587 Lo
H	OEM Specific
J	ISO9141 K-Line

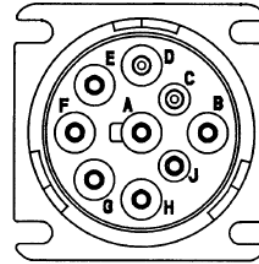

4.6. 9-Pin Deutsch – CAT Industrial Connector – (J1708/J1587, J1939, CAT Data Link)

Pin	Value
A	+12V
B	Ground
C	CAN Shield
D	CAT Data Link (CDL) Hi
E	CAT Data Link (CDL) Lo
F	CAN/J1939 Lo
G	CAN/J1939 Hi
H	ATA/J1587/J1708 Lo
J	ATA/J1587/J1708 Hi

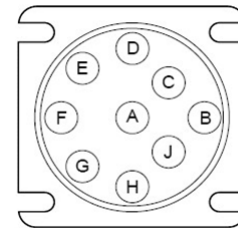

4.7. 9-Pin Deutsch – CNH (Dual CAN and E Used for ISO9141K-Line)

Pin	Value
A	Ground
B	+12V
C	CAN1/J1939 Hi
D	CAN1/J1939 Lo
E	ISO9141 K-Line
F	N/C
G	N/C
H	CAN2/J1939 Hi
J	CAN2/J1939 Lo

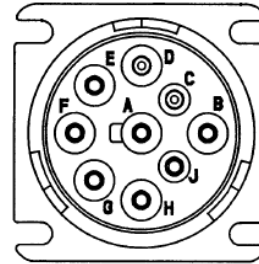

4.1. 9-Pin Deutsch – J1939 "Type 2" for J1939 @ 500k

Pin #	Function
A	Battery Minus (Ground)
B	Battery Plus (+V)
C	CAN/J1939 High
D	CAN/J1939 Low
E	CAN/J1939 Shield
F	See Note 1 (Protocol "High" Line, i.e. CAN/J1708/J1939 High)
G	See Note 1 (Protocol "Low" Line, i.e. CAN/J1708/J1939 Low)
H	OEM Defined
J	OEM Defined

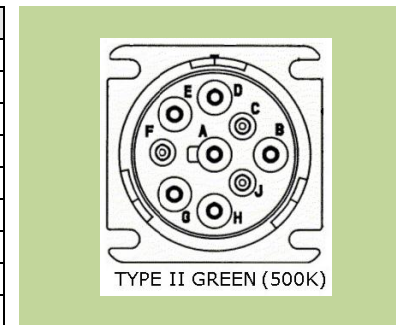

Note 1 – Tool (VDA) Manufacturers should multiplex pins F and G, if used by the tool. Multiplexing pins F and G is necessary to allow support of SAE J1708 or CAN protocol functionality on those pins. Per SAE J1939-13, the vehicle side networks on pins F and G are limited to SAE J1708 and CAN 1Mbps or lower.

5. SAE J1962 OBDII Connector

Signal	Value
1	N/C
2	J1850 +
3	Ford DCL(+) Argentina, Brasil (pre OBD-II) 1997-2000
4	Chassis Ground (GND)
5	Signal Ground
6	CAN High (ISO 15765-4 and SAE-J2234)
7	K line of ISO 9141-2 and ISO 14230-4
8	N/C
9	N/C
10	J1850 -
11	Ford DCL(-) Argentina, Brasil (pre OBD-II) 1997-2000
12	N/C
13	N/C
14	CAN Low (ISO 15765-4 and SAE-J2234)
15	ISO 9141-2 L Line
16	+V

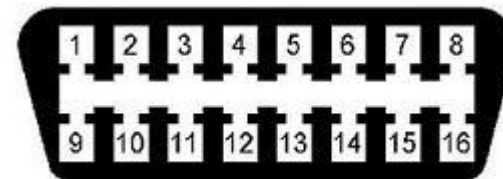

6. SAE J560 Trailer Connector and the DG PLC TestCon

6.1. SAE J560 Trailer Connector Showing PLC4TRUCKS on Terminal 7 – Auxiliary Power

Terminal Number	Conductor Wire Color	Lamp and Signal Circuits
1	White	Ground return to towing vehicle
2	Black	Clearance, side marker, and identification lamps
3	Yellow	Left turn signal and hazard lamps
4	Red	Stop lamps and antilock devices
5	Green	Right turn signal and hazard lamps
6	Brown	Tail and license plate lamps
7	Blue	Auxiliary Power (PLC4TRUCKS)

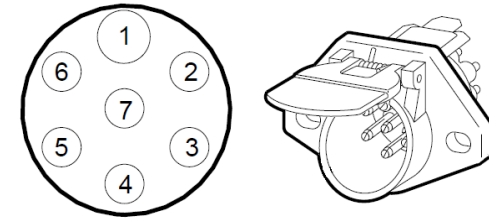

6.2. PLC TestCon Pinouts - Trailer/Tractor Side - (DB15 Female)

DB15F Pin	J560 Pin	Signal Name	Function
1	N/A	No Connection	Reserved
2	N/A	No Connection	Reserved
3	N/A	No Connection	Reserved
4	N/A	Tractor/Trailer Mode	If floating, Tractor Mode
If grounded, Trailer Mode			
5	N/A	External ABS Lamp Input	External 12V ABS Lamp (+12V side)
6	1 (White)	Ground (-VDC)	Ground
7	N/A	CAN Shield	Pass-through for CAN/J1939 Shield
8	7 (Blue)	Power (+VDC/PLC)	Power (9-16VDC)
9	N/A	No connection	Reserved
10	N/A	No connection	Reserved
11	N/A	No connection	Reserved
12	N/A	CAN Low (-)	Pass-through for CAN/J1939 Low
13	N/A	CAN High (+)	Pass-through for CAN/J1939 High
14	N/A	J1708 Low (-)	J1708/J1587 Low (-)
15	N/A	J1708 High (-)	J1708/J1587 High (-)

6.3. PLC TestCon Pinouts - Pigtail Side (To J1708 Adapter) - (DB15 Male)

DB15M Pin	Signal Name	Function
1	No Connection	No Connection
2	No Connection	No Connection
3	No Connection	No Connection
4	No Connection	No Connection
5	No Connection	No Connection
6	Ground (-VDC)	Ground
7	CAN/J1939 Shield	CAN/J1939 Shield
8	Power (+VDC/PLC)	Power (9-16VDC)
9	No connection	No Connection
10	No connection	No Connection
11	No connection	No Connection
12	CAN Low (-)	CAN/J1939 Low
13	CAN High (+)	CAN/J1939 High
14	J1708 Low (-)	J1708/J1587 Low (-)
15	J1708 High (-)	J1708/J1587 High (-)

6.4. PLC TestCon External Wiring Example

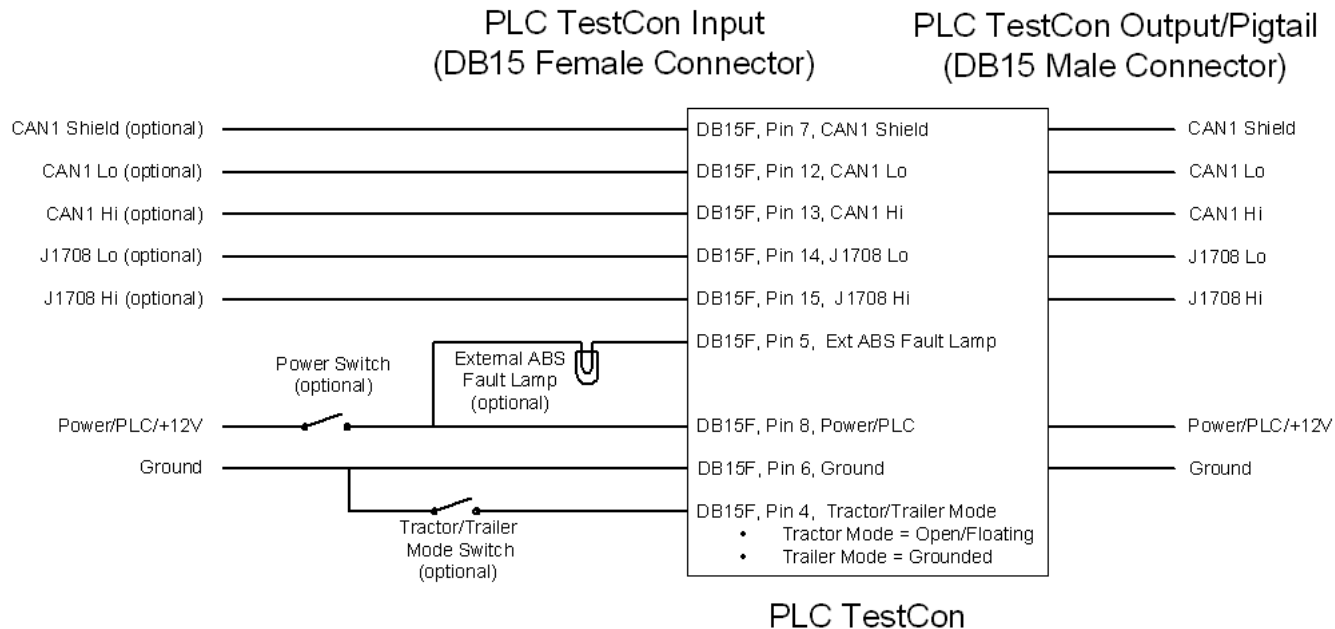

7. D-Sub 9, 15 and 25 Connectors

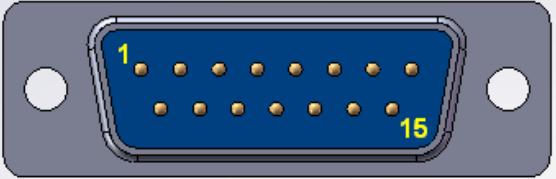
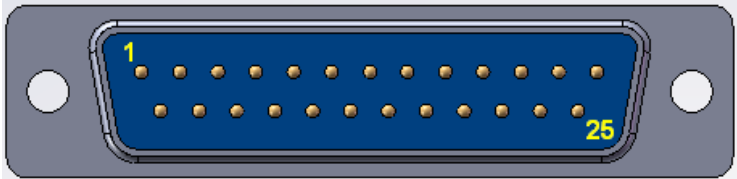
 <p>DB9 Male Connector</p>	<p>Serial (RS-232) variants of the DPA have a DB9 female connector that connects to the PC. The PC is considered to be a DTE (Data Terminal Equipment) device and the DPA is considered to be a DCE (Data Communications Equipment) device (like a modem). Therefore, "generic" DB9M to DB9F and DB9M to DB25F serial cables (commonly found at Walmart and Radio Shack) work for the DPA to PC connection. See the RS-232 table below for specific RS-232 signals.</p>
 <p>DB15 Male Connector</p>	<p>DPA variants (4 Plus and older) will have a DB15 female connector to connect to the vehicle network. Pinouts and signals for this connector are listed in the tables at the beginning of this document.</p>
 <p>DB25 Male Connector</p>	<p>New to the DPA 5 is a DB25 female connector to connect to the vehicle network. Pinouts and signals for this connector are listed in the tables at the beginning of this document.</p>

RS-232 DB9 Pinout Designations

Pin	Name	Notes/Description
1	DCD	Data Carrier Detect
2	RD	Receive Data (Rx)
3	TD	Transmit Data (Tx)
4	DTR	Data Terminal Ready
5	SGND	Ground
6	DSR	Data Set Ready.
7	RTS	Request To Send.
8	CTS	Clear To Send.
9	RI	Ring Indicator

8. USB Connectors Used with the DPA

The DPA variants that use USB as an adapter to PC communications method have a “USB Type A Male” (FIGURE 1 - right) to a “USB Type B Male” (FIGURE 1 - left) cable.

Newer DPA variants such as the DPA 4 Plus and DPA 5 have standoff screws allowing the new DG USB cable (FIGURE 2) to be screwed into the DPA enclosure, reducing the risk of damage to the USB connector on the DPA circuit board.

DG recommends using USB cables that have gold-plated connectors.

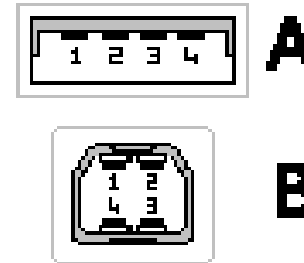

FIGURE 1 – Type B Male (left) to Type A Male (right)



FIGURE 2 – Type A Male (left) to Type B Male (right)

Pin	Name	Cable color	Description
1	VCC	Red	+5 VDC
2	D-	White	Data -
3	D+	Green	Data +
4	GND	Black	Ground



USB Male (Plug) Connectors

9. The New J1939 "Type 2" Connector (for J1939 @ 500k)

There will soon be three common diagnostic connectors:

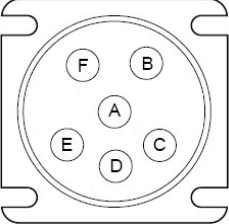
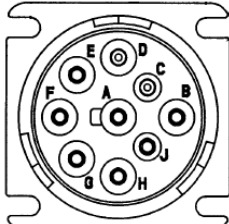
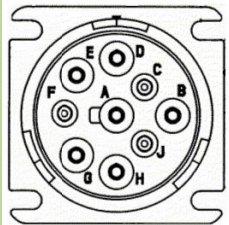
Connector Type	Connector Description	Picture
J1708 – 6-pin Deutsch	Older connector and mostly unused for new manufacture.	 <p>Figure 9.1</p>
J1939 "Type 1" – 9-pin Deutsch	Current model of connector used by OEMs.	 <p>Figure 9.2</p>
J1939 "Type 2" – 9-pin Deutsch	Estimated to be in 2013 or 2014 model year vehicles.	 <p>TYPE II GREEN (500K)</p> <p>Figure 9.3</p>

9.1. Introducing the “Type 2” J1939 Connector

The current “standard” 9-pin Deutsch vehicle diagnostic connector is now being labeled by SAE as the “Type 1” J1939 connector (see Figure 9.2). It conveys both J1708 and J1939 information. The “Type 2” connector (see Figure 9.3) has been added to address the increase in J1939 data bus speed from 250k to 500k bits/second and has been designed with backward compatibility in mind. Where it is not backward compatible, it provides protection for datalink devices.

In short (for more detail, see SAE J1939-13):

- ❑ A “Type 1” cable originally designed for a J1939 speed of 250k will not physically connect to a “Type 2” vehicle designed for 500k. This protects a vehicle network from a VDA or handheld device that may not know about the move to 500k, which might take the 500k bus down.
- ❑ A “Type 2” cable will allow an offboard device to connect to BOTH a “Type 2” and a “Type 1” connector. This will work because the VDA devices and OEM software packages will be doing automatic baud detection so that when they connect, they do not disturb vehicle communications.
- ❑ The “Type 2” connector will be green in color to define that it is 500k J1939, and VDA cables will also be in green to designate that the VDA device is J1939 “500k-capable”.

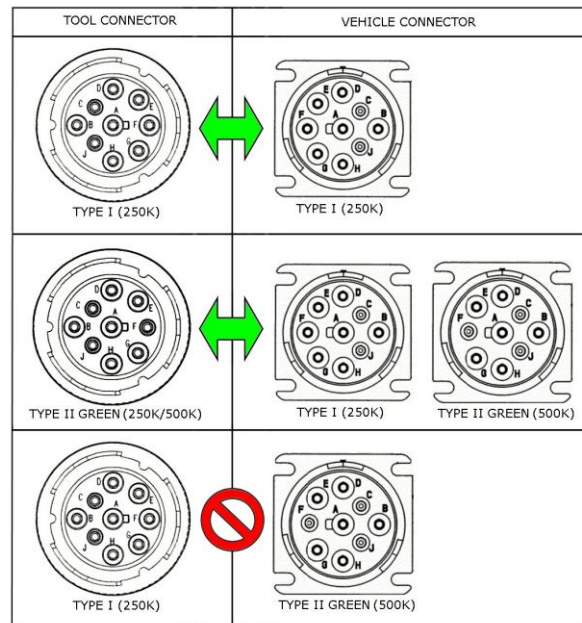

From SAE J1939-13 [Figure 1 -8 – MATING COMBINATIONS AND KEYING]

10. Appendix A. SAE J1708 Connector and Part Numbers

HD10-6-12P
J1708 Cab Mounted Receptacle



HD16-6-12S
J1708 Mating Plug



10.1. SAE J1708 In-Cab Connector Part Number

Receptacle	HD10-6-12P
Pin Contact	0460-220-1231
Sealing Cap	HDC16-6

10.2. SAE J1708 Mating Plug Part Number

Plug	HD16-6-12S
Sockets	0462-210-1231
Strain Relief	HD18-006

11. Appendix B. SAE J1939 "Type 1" Connector and Part Numbers (250k Baud Only)

HD10-9-1939P
Cab Mounted Receptacle



HD10-9-1939P-B022
Cab Mounted Receptacle (with jam nut mount)



HD17-9-1939S
Mating Plug



HD16-9-J1939SE
Mating Plug (with locking ring)



11.1. Type 1 SAE J1939 In-Cab Connector Part Numbers

Receptacle	HD10-9-1939P	HD10-9-1939P-B022
Pin Contact	0460-202-1631	0460-202-1631
Sealing Cap	HDC16-9-E004	HDC16-9-E004

11.2. Type 1 SAE J1939 Mating Plug Part Numbers

Receptacle	HD17-9-1939S	HD17-9-1939SE
Sockets	0462-201-1631	0462-201-1631
Strain Relief	HD18-009	HD18-009

12. Appendix C. SAE J1939 "Type 2" Connector (J1939 @ 500k Capable)

12.1. Type 2 SAE J1939 Connector Pictures

Cab Mounted Receptacle
HD10-9-1939P-P080

PICTURE TBD

Cab Mounted Receptacle (with jam nut mount)
HD10-9-1939P-BP03

PICTURE TBD

Mating Plug
HD17-9-1939S-P080

PICTURE TBD

Mating Plug (with locking ring)
HD16-9-1939S-P080

PICTURE TBD

12.2. Type 2 SAE J1939 In-Cab Connector Part Numbers

Receptacle	HD10-9-1939P	HD10-9-1939P-B022
Pin Contact	0460-202-1631	0460-202-1631
Sealing Cap	HDC16-9-E004	HDC16-9-E004

12.3. Type 2 SAE J1939 Mating Plug Part Numbers

Receptacle	HD17-9-1939S	HD17-9-1939SE
Sockets	0462-201-1631	0462-201-1631
Strain Relief	HD18-009	HD18-009